



Protect your critical compressors
from failure and shutdowns.

Fisher™ Optimized Antisurge Control Valves

Achieve maximum compressor efficiency with valves that offer superior dynamic response, robustness, and easy tuning.



Fisher Optimized Antisurge Control Valves

The right choice for high reliability, fine control, fast stroking, and easy tuning of your most critical application.

Finally a robust, high-performance antisurge valve that can be easily implemented and serviced in the field. A valve engineered from the ground up to meet the specific needs of compressor antisurge applications requiring the ultimate in control valve reliability.

Gone are the days of complicated actuation systems requiring factory-authorized personnel to tune and commission. The Fisher optimized antisurge valve from Emerson makes short work of valve tuning, saving you money during commissioning. It also pays back your original investment many times over during the life of the equipment with superior dynamic performance.

We understand how to integrate antisurge control valve components—the valve, actuator, FIELDVUE™ digital valve controller, and associated instruments—into an effective design, thanks to more than 135 years of process control experience. That's why you'll find the Fisher optimized antisurge valve to be **best-in-class for reliability, control, and commissioning.**



Typical 3-Stage Antisurge System Schematic

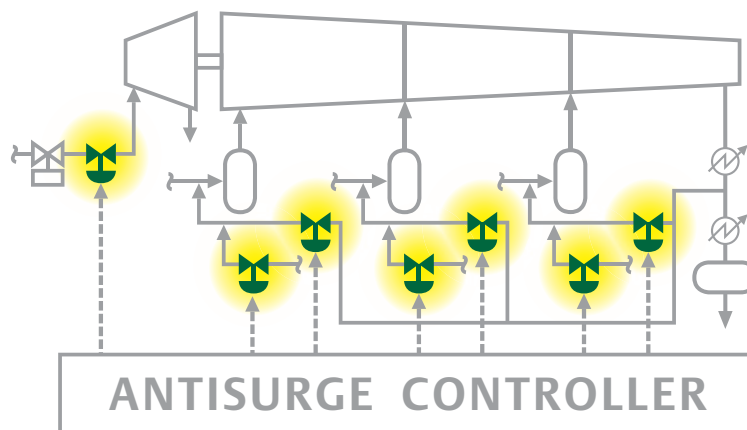

Antisurge System

High performance antisurge valve actuation will help you get the most from sophisticated antisurge controllers.

Site Testing >>

Certified Emerson technicians worldwide can perform site testing of your antisurge valve according to the FGS 4L12 test.



General Specification

FGS 4L12

Site Performance Testing of Fisher Optimized Control Valves

Page 1 of 11



General Specification
FGS 4L11

Factory Performance Testing of Compressor Antisurge Valves

Page 1 of 21



Rigorous Factory Testing

Your compressor antisurge application is no place for uncertainty. With the Fisher optimized antisurge valve and the Fisher FGS 4L11 test you have proof of performance. The FGS 4L11 test validates the valve's static performance, dynamic performance, and servo robustness. Find out more from your Emerson sales contact.

High Reliability

Components within the Fisher optimized antisurge valve were selected with high reliability in mind.

The FIELDVUE digital valve controller features a rugged I/P converter, a robust pneumatic relay, and potted electronics to protect it from harsh plant environments.

Dual certified as intrinsically safe and explosion proof, the FIELDVUE digital valve controller also satisfies the requirements of the European ATEX directive. Its enclosure meets NEMA 4X and IEC 60529 IP66 criteria.

You can feel confident that FIELDVUE hardware and software are proven. The FIELDVUE digital valve controller is used in critical applications in which reliability is paramount, such as safety instrumented systems.

Cushioned Actuator

Mechanical air cushions within the high-speed actuator cylinder provide controlled deceleration to help protect actuator and valve components. A check valve provides full speed performance when the valve is moving away from the travel stop.

No Sliding Parts to Wear

Non-contact feedback technology in the FIELDVUE digital valve controller eliminates the potentiometer and has no sliding parts to wear. A magnet array and Hall Effect sensor are used to detect valve position. The heavy-duty mounting is designed for the harshest environments.

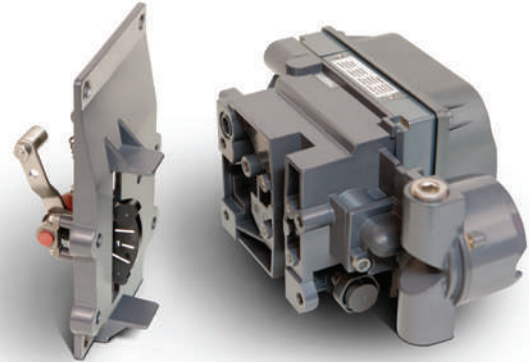

Robust Instrument Mounting

Designed to withstand vibration associated with compressor piping systems, the FIELDVUE digital valve controller mounting bracket features an integral antirotator and heavy duty gussets. All mounting parts are stainless steel, easily accessible, and facilitate remote mounting of the instrument.



A Case-In-Point

Arabian Petrochemical Company's (Petrokemya, a SABIC affiliate) ethylene plant experienced capacity issues with its main compressor antisurge valves—the most critical valves in the facility.

The existing valves were undersized for the valve outlet velocity and took a long time to respond. Turbulence, caused by the difference in gas velocity between the valve outlet and larger downstream piping, contributed to unacceptable noise levels.

Emerson's solution for the plant consisted of five fabricated valve types, each incorporating proven WhisperFlo™ noise attenuation trim. Elevated pressure drops and high flow rates inherent to antisurge applications warrant advanced noise-control valve trims. WhisperFlo trim protects the compressor and piping system from damaging vibration while providing superior noise reduction. The trim was characterized to match capacity with the complex compressor performance curve. The fabricated valve bodies provided flexibility in meeting the existing face-to-face dimensions.

The valves were equipped with a fast-stroke, antisurge accessory package, which reduced the overall cost of accessories while improving long-term performance. FIELDVUE digital valve controllers provide performance diagnostics and monitoring capabilities for these critical valves.

Reduced Noise and Vibration

WhisperFlo is a multipath, multistage valve trim capable of reducing noise levels by as much as 40 dBA. Flow patterns formed by laser cut discs help ensure repeatable noise attenuation and reduced pipe vibration.

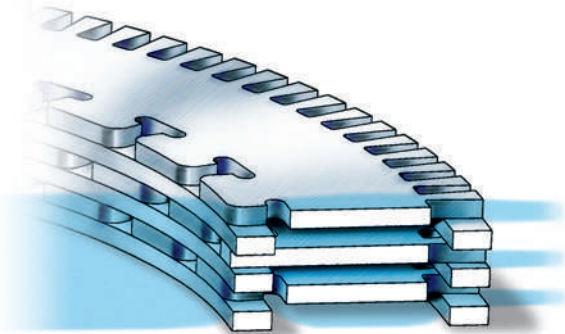

Ready For Any Climate

Elastomers within Fisher instruments are designed to withstand temperatures as low as -40°C (-40°F) or as high as 93°C (200°F) while providing excellent resistance to common impurities within plant air.

Emerson engineers rely on decades of non-metallic test experience to accurately select elastomers for long-term reliability.



Partial Stroke Testing and On-Seat Diagnostics

The FIELDVUE digital valve controller automatically checks the condition of the valve during each partial stroke test. Diagnostics such as valve packing friction, air path leakage, valve sticking, actuator spring rate, and bench set can be collected, viewed, and analyzed using ValveLink™ software while the valve remains in service, without impacting the process.

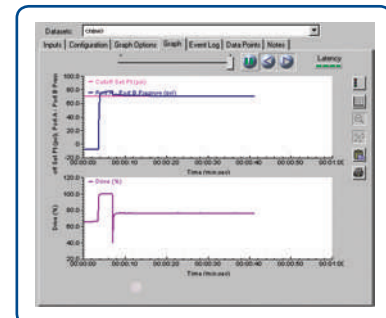
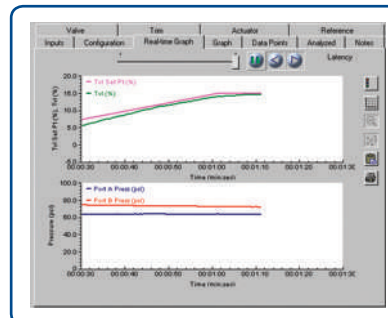

Peak Efficiency Lowers Operating Costs

By moving the compressor's operating point closer to the surge limit line, you can operate more efficiently. This can mean significant reductions in operating costs—as much as \$250,000 USD annually for a relatively small 4,500-horsepower compressor. Larger compressors that are common to liquefied natural gas facilities could see much larger savings.

The faster and more accurately an antisurge valve moves, the more the savings. The Fisher optimized antisurge valve is designed to deliver high-performance actuation and improved control.

The Fisher optimized antisurge valve achieves higher gains, responds better, and has remarkable stability thanks in part to minor loop feedback and other proprietary techniques. Easily customized for critical application requirements, these techniques marry seamlessly with volume boosters to handle nearly any actuator requirements.

Exclusively On Fisher Valves

The FIELDVUE digital valve offers an antisurge-specific tuning capability that is available exclusively on Fisher valves as part of the Fisher Optimized Digital Valve.



Fast Stroke and Controlled Deceleration

In one second, this Fisher optimized antisurge valve reaches the capacity required to protect the compressor. It safely decelerates thanks to a cushioned actuator.

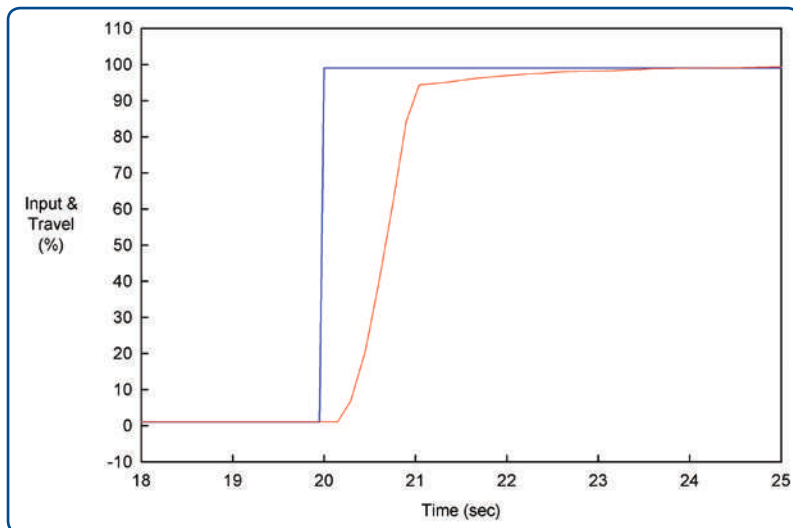

A liquefied natural gas facility needed to replace all of its existing propane and mixed refrigerant compressor antisurge valves. After seeing a demonstration of the Fisher optimized antisurge valve, the plant turned to Emerson who has proven its ability to understand and meet stringent valve performance criteria.

The 25 existing valves were replaced by NPS 12 through NPS 30 Fisher optimized antisurge valves.

A Case-In-Point

- The valves open in less than two seconds, as well as meet stringent closed-loop control criteria.
- The measured linearity is less than 0.75%, and the valves have minimal overshoot in the open and closed directions.
- It often requires about 12 hours to tune a non-Fisher antisurge valve. With its fewer accessories and diagnostic capabilities, tuning time for a Fisher optimized antisurge valve takes only minutes.

All this adds up to a more reliable antisurge valve solution for protecting compressors and increasing process efficiency.

Fully Balanced Trim

The huge balance area of the unique Fisher spoked plug helps the control valve resist pressure pulsations.



High Resolution

This Fisher optimized antisurge valve responds to bidirectional step sizes of 0.25% thru 10% accurately and quickly. (Sample results from Fisher factory assurance testing on production equipment.)

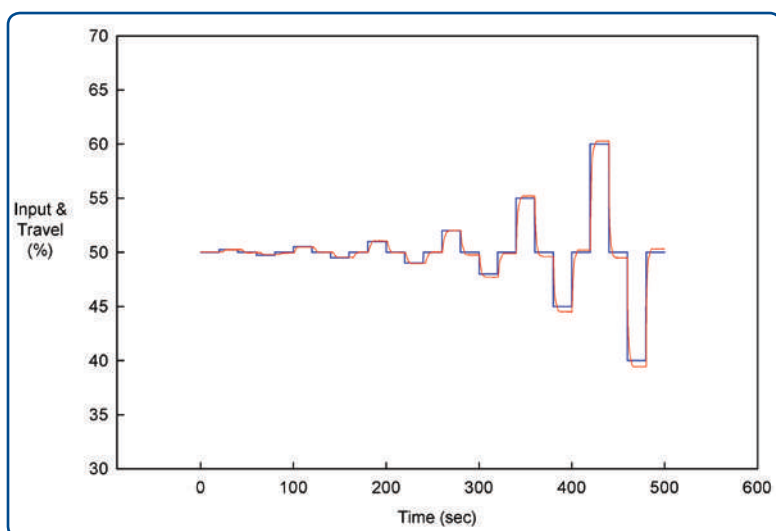

Negligible Overshoot

Overshoot is negligible for small and large steps. (Sample results from Fisher factory assurance testing on production equipment.)

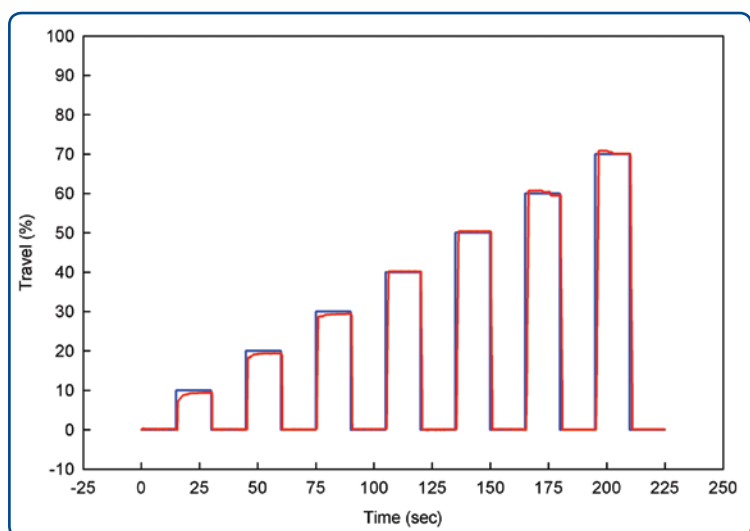

Reduce Commissioning Time and Lower Costs

Factory expertise is not required to tune the Fisher optimized antisurge valve. A technician may simply use ValveLink software's performance tuner or the Stabilize/Optimize feature with real-time graphics (shown far right). Configuration and tuning can also be performed remotely by operators as process requirements change.

Avoid the high cost of running separate power and signal wiring by using the Fisher optimized antisurge valve. Its FIELDVUE digital valve controller uses two-wire 4 to 20 mA loop power.

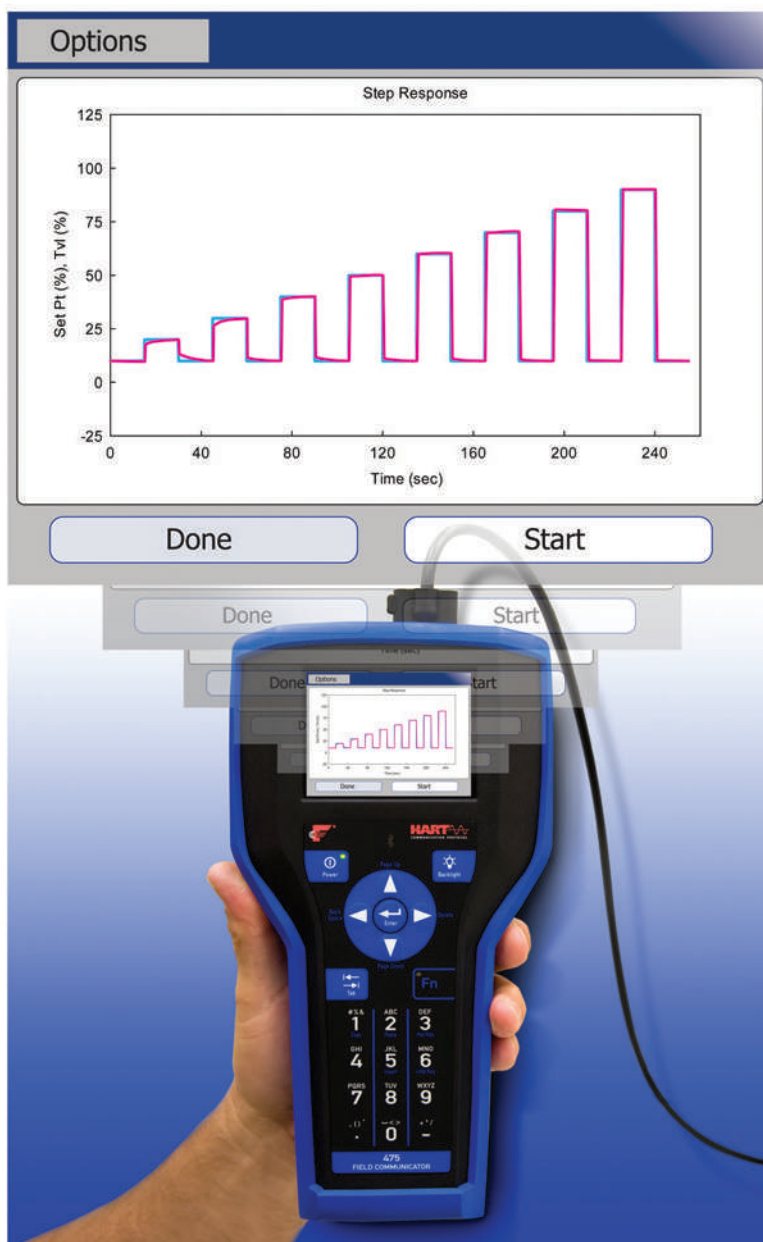

Advanced, Local Tuning

Tune your Fisher optimized antisurge valve using ValveLink Mobile software. You can monitor the valve response and quickly adjust gains to optimize performance. (Large step test study shown in ValveLink Mobile software.)

Simple Setup

The setup wizard within ValveLink software guides the technician through three simple dialog screens for the Fisher optimized antisurge valve. (Setup wizard shown in ValveLink software.)

The figure shows a screenshot of the 'Actuator Information' dialog box in the ValveLink software. The dialog box has a title bar that says 'Actuator Information'. It contains several fields for configuration: 'Actuator Make' is set to 'Fisher Controls', 'Actuator Model' is set to '505CL8', and 'Actuator Size' is set to '10'. There is a checkbox for 'Volume Booster / Quick Release' which is currently unchecked. Below these fields is a 'Setup Wizard' dialog box with a progress bar showing 85% completion. The 'Setup Wizard' dialog box has a 'Be' button on the left and a 'Cancel' button on the right.



2625 Volume Booster

The Fisher 2625 volume booster integrates seamlessly with the FIELDVUE digital valve controller and ValveLink software for robust, high performance tuning.



Lead-Lag Remote Tuning with Simple Setup Wizard

The lead-lag filter in the FIELDVUE digital valve controller can be used to improve the response to small amplitude steps by overdriving the set point. Asymmetric adjustments allow the response to be set independently in the opening and closing directions. Integrated, real-time graphics allow adjustments to be done remotely.

Stabilize/Optimize Feature

It is easy for anyone to get full control of the Fisher optimized antisurge valve without disturbing operations using the Stabilize/Optimize feature.

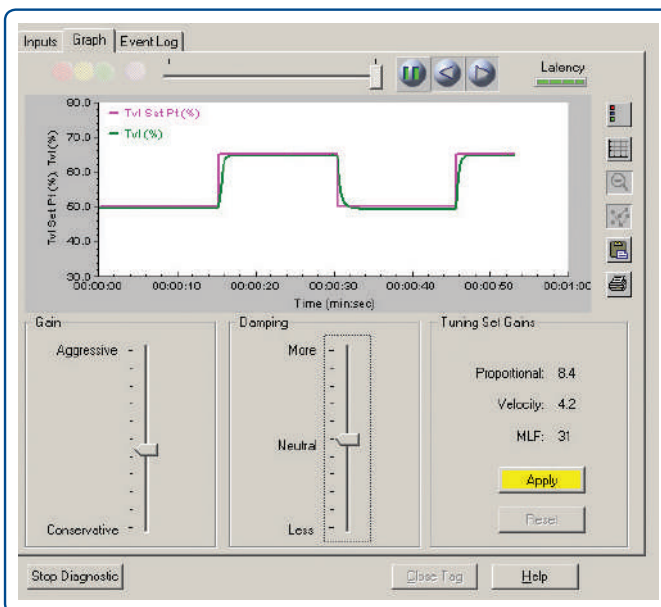
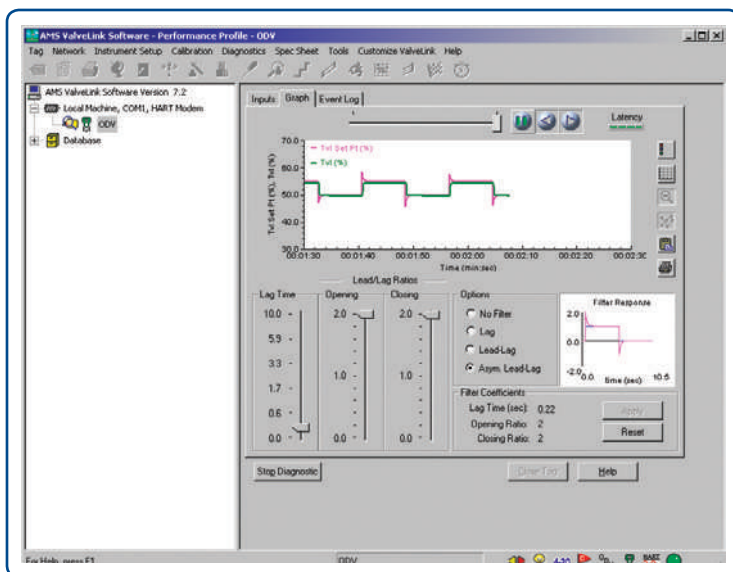

SS-263 Volume Booster

Today's process plants require larger control valves than ever before. This increase in valve size has stretched traditional volume boosters to their limit. The SS-263 volume booster brings the field-proven performance of the 2625 volume booster to a whole new breed of large-scale control valves.

The rock-solid reputation of the 2625 volume booster was designed specifically for use on control valves with the feature set and dynamic response required to integrate seamlessly with the FIELDVUE digital valve controller.



Easy to Repair

Modular construction of the trim allows for easy field maintenance of all wear components.



High Vibration Applications

Booster body designed with integrated high-vibration mounting options to handle the most severe applications.

Desirable Failure Mode

Control valve continues to work in the event of a booster diaphragm or spring failure.

Enhanced Throttling Control

High-performance trim package allows the SS-263 to seamlessly integrate with the FIELDVUE digital valve controller to maintain precise throttling performance.

The SS-263 volume booster carries on this tradition on a grand scale. With three times the capacity of the 2625 volume booster, accessory mountings can be greatly simplified and the angle body style results in a cleaner, more compact package.

The rugged design features of the 2625 volume booster have been preserved while material selection has been improved. The post-guided poppet valve design eliminates problematic spool valves and continues to work even in the presence of instrument air contaminants such as sand, rust, oil, and desiccants.

Modular trim components improve field maintenance and optional high vibration mountings ready the SS-263 volume booster for the most severe applications.



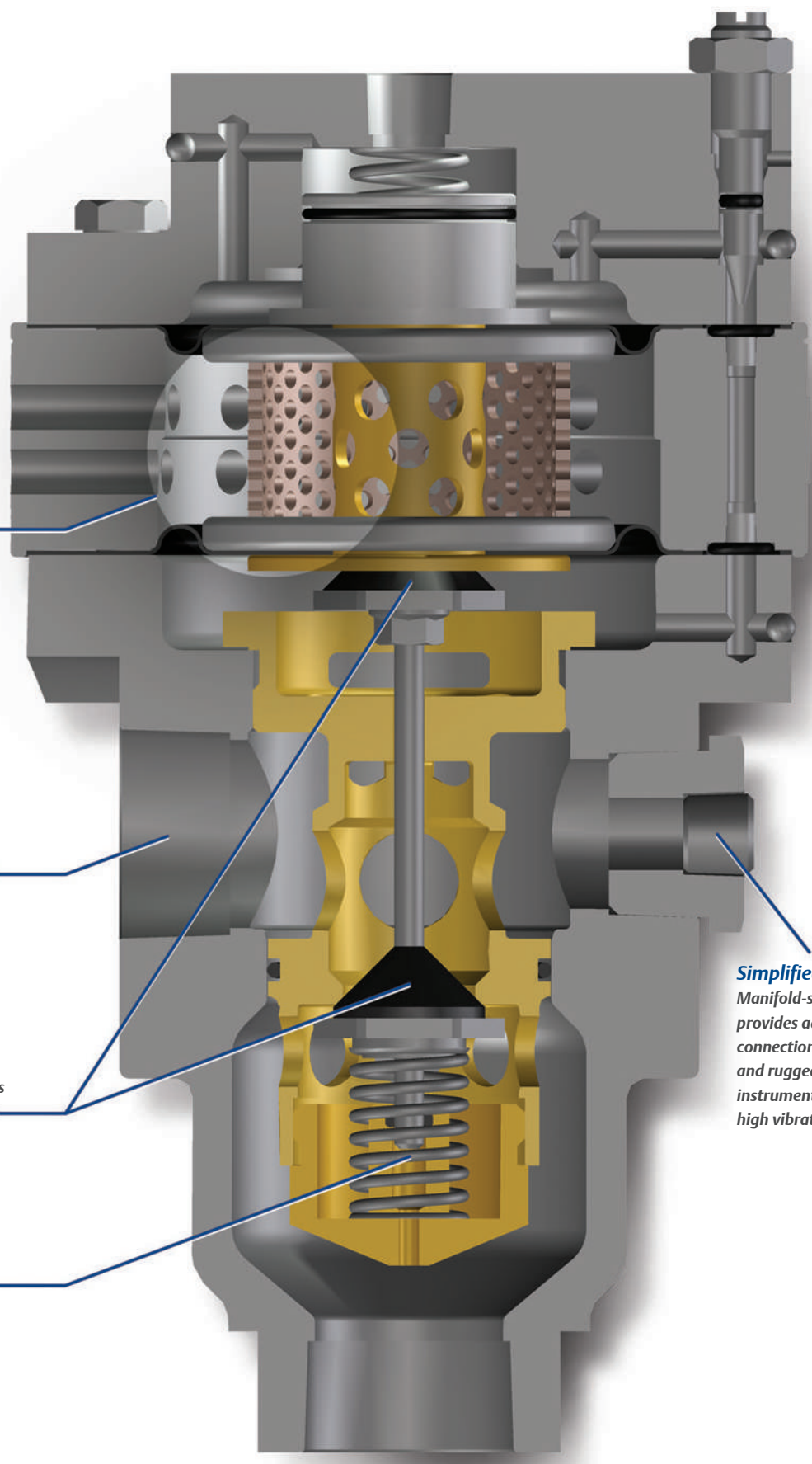

Noise Attenuation
Three-stage exhaust trim greatly reduces noise levels.

High Capacity
Delivers three times as much air as a 2625 volume booster to simplify accessory mounting on large actuators.

Bubble Tight Shutoff
Soft seat construction ensures the control valve maintains its desired fail position upon loss of plant air.

High Cycle Life
Low-stress springs and rolling, convoluted diaphragms provide the durability to attain 1 million-plus cycles.

Simplified Tubing
Manifold-style body provides additional air connections to simplify and ruggedize the instrument tubing for high vibration service.

View a demonstration of a Fisher optimized antisurge valve in-person.

● Marshalltown, Iowa, USA

● Houston, Texas, USA

● Cernay, France

● Jubail, Saudi Arabia

Visit **Fisher.com** to contact a sales office and schedule a demonstration at a facility near you.

FISHER™

Emerson Automation Solutions
Marshalltown, Iowa, 50158 USA
Sorocaba, 18087 Brazil
Cernay, 68700 France
Dubai, United Arab Emirates
Singapore 128461 Singapore



Fisher.com



Facebook.com/FisherValves



LinkedIn.com/groups/Fisher-3941826



Twitter.com/FisherValves

© 2019 Fisher Controls International LLC. All rights reserved. Fisher, FIELDVUE, WhisperFlo, and ValveLink are marks owned by one of the companies in the Emerson Automation Solutions business unit of Emerson Electric Co. Emerson, and the Emerson logo are trademarks and service marks of Emerson Electric Co. All other marks are the property of their respective owners. The contents of this publication are presented for informational purposes only, and while every effort has been made to ensure their accuracy, nothing herein is to be construed as a warranty or guarantee, express or implied, regarding the products or services described herein or their use, performance, merchantability or fitness for a particular purpose. Individual results may vary. All sales are governed by our terms and conditions, which are available upon request. We reserve the right to modify or improve the designs or specifications of our products at any time without notice. Responsibility for proper selection, use and maintenance of any product or service remains solely with the purchaser and end user. D351146X012 | Jun19



EMERSON™

CONSIDER IT SOLVED™